

SIRIUS HRI

High-pressure discharge lamps with reflector



Användningsområde

- Architecture & Architainment

Produktfördelar

- Lightweight and compact reflector lamps
- Perfectly suited for small and lightweight moving heads
- Optimerat brännarutförande tillåter alla brännarpositioner
- High luminance through very short arc and high pressure
- Ljusstark belysning för briljanta ljuseffekter
- Lång livslängd
- Easy lamp replacement
- Stable light output over the entire lifetime



Datablad produktfamilj

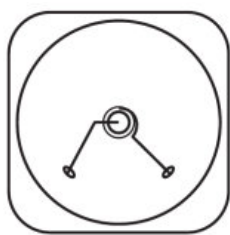
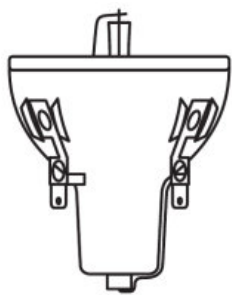

666507_SIRIUS HRI 100W

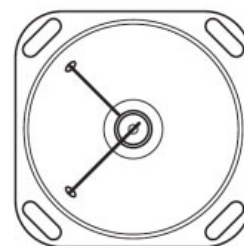
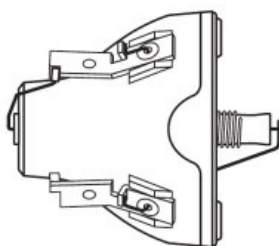

350611_SIRIUS HRI 132W

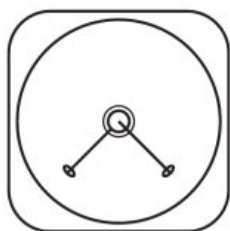
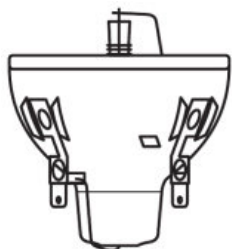

488735_SIRIUS HRI 132W

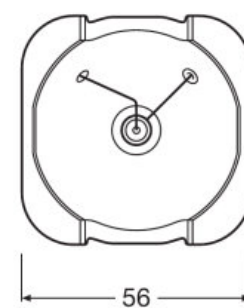
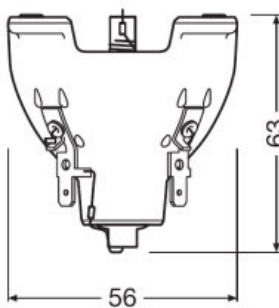

501950_SIRIUS HRI 330W

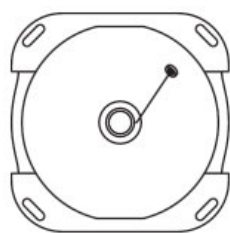
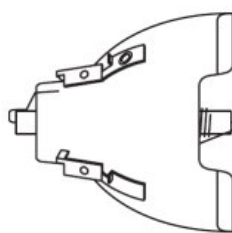

333382_SIRIUS HRI 330W

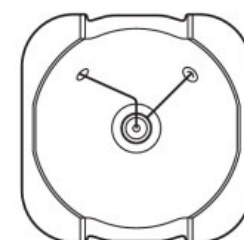
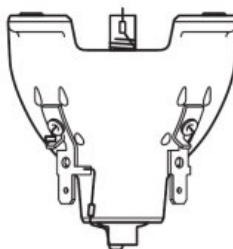

501965_SIRIUS HRI 330W

Datablad produktfamilj

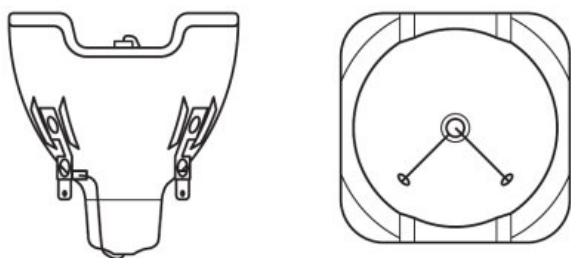

488771_SIRIUS HRI 330W X8

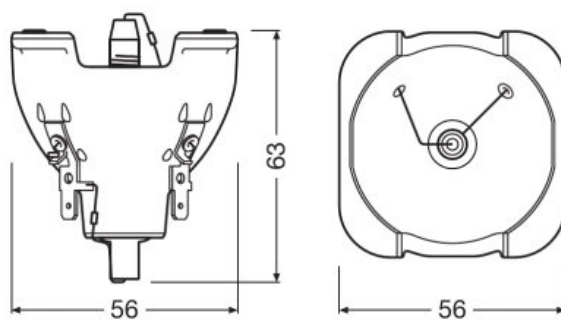

501949_Sirius HRI 330W XL

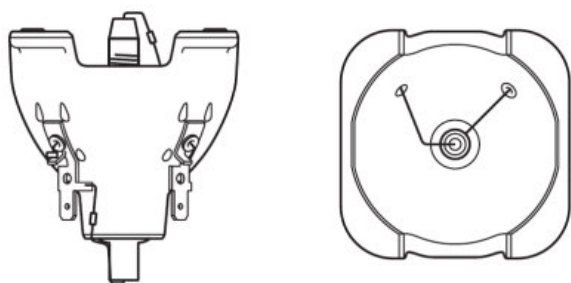

501963_Sirius HRI 330W XL

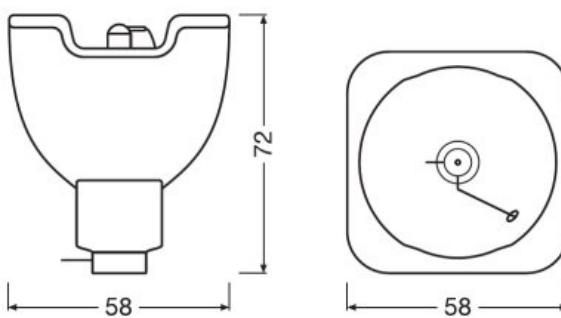

SIRIUS HRI 371W

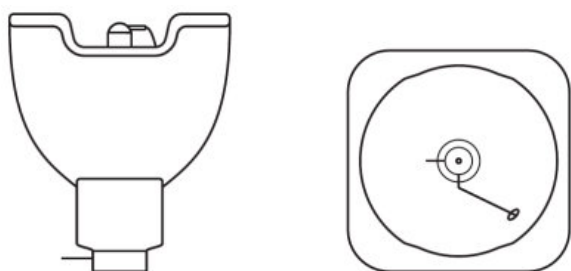

SIRIUS HRI 371W

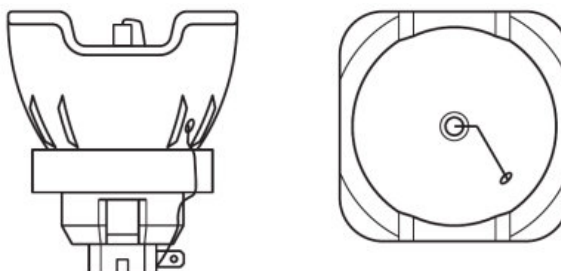

668858_SIRIUS HRI 440W

Datablad produktfamilj

Tekniska data

Produktbeskrivning	Elektriska data		Fotometrisk data				Ljustekniska värden
	Nominell watttal	Märkström	Nominell Ljusflöde	Färgtemperatur	Färgåtergivningsindex Ra	Maximal färgtemperatur	Fokuseringslängd
SIRIUS HRI 100 W	100,00 W	1,8 A	3680 lm	9000 K	60	9300 K	30.0 mm
SIRIUS HRI 132 W SC	132,00 W	1,8 A	5150 lm	9200 K	60	9200 K	37.7 mm
SIRIUS HRI 140 W RO	140,00 W	1,9 A	5400 lm	9200 K	60	9200 K	37.7 mm
SIRIUS HRI 190 W+	190,00 W	2,7 A	8100 lm	8200 K	73		
SIRIUS HRI 230 W	230,00 W	3,3 A	9500 lm	8000 K	75	8000 K	34,5 mm
SIRIUS HRI 231 W	231,00 W	3,3 A	10800 lm	8000 K	75		
SIRIUS HRI 251 W	250,00 W	3,5 A	12000 lm	8000 K	77		
SIRIUS HRI 260 W PRO	260,00 W	3,7 A	13500 lm	7800 K	79		
SIRIUS HRI 280 W	280,00 W	4 A	11500 lm	7800 K	78	7800 K	35.5 mm
SIRIUS HRI 280 W RO	280,00 W	4 A	11500 lm	7800 K	78		
SIRIUS HRI 281 W	281,00 W	4 A	13000 lm	7800 K	78		
SIRIUS HRI 310 W PRO	310,00 W	5 A	15500 lm	7650 K	85		
SIRIUS HRI 311 W	310,00 W	3,3 A	14500 lm	8000 K	75		
SIRIUS HRI 330 W	330,00 W	5 A	18000 lm	7400 K	86	7400 K	31.0 mm
SIRIUS HRI 330 W X8	330,00 W	4,4 A	18000 lm	8000 K	85		
SIRIUS HRI 330 W XL	330,00 W	5 A	16500 lm	7250 K	71		
SIRIUS HRI 371 W	371,00 W	5 A	18300 lm	7650 K	85		
SIRIUS HRI 371 W S	371,00 W	5 A	19800 lm	7650 K	85		
SIRIUS HRI 371 W +	370,00 W	5 A	18300 lm	7650 K	85		
HRI 371 W S +	370,00 W	5 A	19800 lm	7650 K	85		
SIRIUS HRI 380 W Pro	380,00 W	5 A	20000 lm	7700 K	85		
SIRIUS HRI 420 W	420,00 W	5 A	22000 lm	7700 K	85		
SIRIUS HRI 440 W	440,00 W	5,3 A	20000 lm	7000 K	80	7000 K	41.0 mm
SIRIUS HRI 440 W H	440,00 W	5,3 A	18000 lm	7000 K	75		
SIRIUS HRI 440 W S	440,00 W	4,4 A	22800 lm	7000 K	80		
SIRIUS HRI 440 W X	440,00 W	5,3 A	22800 lm	7000 K	80		
SIRIUS HRI 461 W	461,00 W	5,3 A	24000 lm	7500 K	80		
SIRIUS HRI 461 W S	461,00 W	5,3 A	24000 lm	7500 K	80		
SIRIUS HRI 470 W S	470,00 W	5,3 A	21500 lm	7000 K	80		
SIRIUS HRI 470 W RO	470,00 W	5,3 A	19500 lm	7500 K	80		
SIRIUS HRI 470 W XL	470,00 W	5,3 A	24000 lm	7500 K	80		
SIRIUS HRI 471 W SN	471,00 W	5,3 A	20000 lm	7500 K	80		
SIRIUS HRI 550 W	550,00 W	6,1 A	28000 lm	7000 K	75		

Produktbeskrivning	Ljusöppning max	Mått		Livslängder	Användningsområden	
		Diameter	Längd	Livslängd	Brinnläge	Forcerad kylning
SIRIUS HRI 100 W	5x3.8 mm	45,0 mm	53,0 mm	6000 h	Universal	Forcerad

Datablad produktfamilj

Produktbeskrivning	Ljusöppning max	Mått		Livslängder	Användningsområden	
		Diameter	Längd	Livslängd	Brinnläge	Forcerad kylning
SIRIUS HRI 132 W SC	5x3.8 mm	46,0 mm	max. 44 mm	6000 h	Universal	Forcerad
SIRIUS HRI 140 W RO	5x3.8 mm	46,0 mm	max. 44 mm	6000 h	Universal	Forcerad
SIRIUS HRI 190 W+		51,0 mm	54,5 mm			
SIRIUS HRI 230 W	5x3.8 mm	51,0 mm	54,5 mm	2500 h	Universal	Forcerad
SIRIUS HRI 231 W		51,0 mm	50,0 mm	2000 h	Universal	
SIRIUS HRI 251 W		51,0 mm	61,0 mm	3000 h		
SIRIUS HRI 260 W PRO		51,0 mm	50,0 mm	6000 h		
SIRIUS HRI 280 W	5x3.8 mm	51,0 mm	54,5 mm	2000 h	Universal	Forcerad
SIRIUS HRI 280 W RO		51,0 mm	54,5 mm	2000 h	Universal	
SIRIUS HRI 281 W		51,0 mm	50,0 mm	2000 h	Universal	
SIRIUS HRI 310 W PRO		58,0 mm	72,0 mm	6000 h		
SIRIUS HRI 311 W		51,0 mm	50,0 mm	1500 h		
SIRIUS HRI 330 W	8.0 mm	56,0 mm	63,0 mm	1500 h	Universal	Forcerad
SIRIUS HRI 330 W X8		58,0 mm	66,0 mm	1500 h	Universal	
SIRIUS HRI 330 W XL		56,0 mm	63,0 mm	1500 h	Universal	
SIRIUS HRI 371 W		58,0 mm	72,0 mm	1500 h	Universal	
SIRIUS HRI 371 W S		58,0 mm	72,0 mm	1500 h	Universal	
SIRIUS HRI 371 W +		58,0 mm	72,0 mm	3000 h		
HRI 371 W S +		58,0 mm	72,0 mm	3000 h		
SIRIUS HRI 380 W Pro		58,0 mm	72,0 mm	2500 h		
SIRIUS HRI 420 W		58,0 mm	72,0 mm	2500 h		
SIRIUS HRI 440 W	8.0 mm	58,0 mm	71,0 mm	1500 h	Universal	Forcerad
SIRIUS HRI 440 W H		65,0 mm	60,0 mm	1500 h	Universal	
SIRIUS HRI 440 W S		11,8 mm	71,0 mm	1500 h	Universal	
SIRIUS HRI 440 W X		58,0 mm	71,0 mm	1500 h		
SIRIUS HRI 461 W		60,0 mm	67,0 mm	1500 h	Universal	
SIRIUS HRI 461 W S		60,0 mm	67,0 mm	1500 h	Universal	
SIRIUS HRI 470 W S		58,0 mm	71,0 mm	1500 h	Universal	
SIRIUS HRI 470 W RO		60,0 mm	67,0 mm	1500 h	Universal	
SIRIUS HRI 470 W XL		60,0 mm	67,0 mm	1500 h	Universal	
SIRIUS HRI 471 W SN		60,0 mm	67,0 mm	1500 h	Universal	
SIRIUS HRI 550 W		60,0 mm	67,0 mm	1500 h		

Produktbeskrivning	Certifikat och Standarder	Environmental information Information according Art. 33 of EU Regulation (EC) 1907/2006 (REACH)		
	EEI – Energi märkning	Date of Declaration	Primary Article Identifier	Candidate List Substance 1
SIRIUS HRI 100 W	B	01-09-2023	4052899321656 4052899329119	No declarable substances contained
SIRIUS HRI 132 W SC	A	07-04-2022	4052899011335 4052899028708 4052899197404	No declarable substances contained
SIRIUS HRI 140 W RO	A	21-04-2023	4052899224056 4052899258969	No declarable substances contained

Datablad produktfamilj

Produktbeskrivning	Certifikat och Standarder	Environmental information Information according Art. 33 of EU Regulation (EC) 1907/2006 (REACH)		
	EEI – Energi märkning	Date of Declaration	Primary Article Identifier	Candidate List Substance 1
SIRIUS HRI 190 W+		10-02-2023	4008321866592 4052899475397	No declarable substances contained
SIRIUS HRI 230 W	A	07-04-2022	4008321678225 4008321810311	No declarable substances contained
SIRIUS HRI 231 W	A	07-04-2022	4052899512634 4052899553521 4062172041430 4062172128681 4062172212311	No declarable substances contained
SIRIUS HRI 251 W		08-09-2023	4062172212458 4062172212434	No declarable substances contained
SIRIUS HRI 260 W PRO		09-08-2023	4062172118941 4062172118927	
SIRIUS HRI 280 W	A	22-09-2023	4008321734303 4008321810342	No declarable substances contained
SIRIUS HRI 280 W RO	A	22-09-2023	4052899082151 4052899110397	No declarable substances contained
SIRIUS HRI 281 W	A	03-02-2023	4052899553552 4062172041454 4062172128704	No declarable substances contained
SIRIUS HRI 310 W PRO		01-09-2023	4062172085304 4062172169424 4062172169455	No declarable substances contained
SIRIUS HRI 311 W		03-02-2023	4062172169363	
SIRIUS HRI 330 W		07-04-2022	4008321754448 4008321810373	No declarable substances contained
SIRIUS HRI 330 W X8	A	07-04-2022	4052899140295 4052899140325 4052899224346	No declarable substances contained
SIRIUS HRI 330 W XL		07-04-2022	4008321848765 4052899195431	No declarable substances contained
SIRIUS HRI 371 W		26-08-2022	4062172057004 4062172056984 4052899558649 4052899558670	No declarable substances contained
SIRIUS HRI 371 W S		07-04-2022	4062172056953 4062172056939 4052899558618	No declarable substances contained
SIRIUS HRI 371 W +		07-06-2023	4062172110341 4062172110327	
HRI 371 W S +		01-09-2023	4062172110396 4062172110372	No declarable substances contained
SIRIUS HRI 380 W Pro		11-04-2022	4062172168625 4062172168601	
SIRIUS HRI 420 W		01-09-2023	4062172192750 4062172192736	No declarable substances contained

Datablad produktfamilj

Produktbeskrivning	Certifikat och Standarder	Environmental information Information according Art. 33 of EU Regulation (EC) 1907/2006 (REACH)		
	EEI – Energi märkning	Date of Declaration	Primary Article Identifier	Candidate List Substance 1
SIRIUS HRI 440 W	A	07-04-2022	4052899222212 4052899259096 4052899553644 4052899570566 4052899587892	No declarable substances contained
SIRIUS HRI 440 W H		07-04-2022	4052899509528 4052899576735	No declarable substances contained
SIRIUS HRI 440 W S	A	07-04-2022	4052899276543 4052899329140	No declarable substances contained
SIRIUS HRI 440 W X		07-04-2022	4062172017442	No declarable substances contained
SIRIUS HRI 461 W		07-04-2022	4052899532274 4052899553613	No declarable substances contained
SIRIUS HRI 461 W S		07-04-2022	4052899532298 4052899553583	No declarable substances contained
SIRIUS HRI 470 W S		07-04-2022	4052899580985 4062172169301	
SIRIUS HRI 470 W RO	A	07-04-2022	4052899476998 4052899477018	No declarable substances contained
SIRIUS HRI 470 W XL		07-04-2022	4052899581166 4062172017473 4062172168281	No declarable substances contained
SIRIUS HRI 471 W SN		07-04-2022	4052899581005 4062172040358	No declarable substances contained
SIRIUS HRI 550 W		07-04-2022	4062172008761 4062172078122	

Produktbeskrivning	Declaration No. in SCIP database
SIRIUS HRI 100 W	No declarable substances contained
SIRIUS HRI 132 W SC	In work
SIRIUS HRI 140 W RO	In work
SIRIUS HRI 190 W+	In work
SIRIUS HRI 230 W	In work
SIRIUS HRI 231 W	In work
SIRIUS HRI 251 W	No declarable substances contained
SIRIUS HRI 260 W PRO	In work
SIRIUS HRI 280 W	In work
SIRIUS HRI 280 W RO	In work
SIRIUS HRI 281 W	In work
SIRIUS HRI 310 W PRO	In work
SIRIUS HRI 311 W	In work
SIRIUS HRI 330 W	In work

Datablad produktfamilj

Produktbeskrivning	Declaration No. in SCIP database
SIRIUS HRI 330 W X8	In work
SIRIUS HRI 330 W XL	In work
SIRIUS HRI 371 W	In work
SIRIUS HRI 371 W S	In work
SIRIUS HRI 371 W +	In work
HRI 371 W S +	No declarable substances contained
SIRIUS HRI 380 W Pro	In work
SIRIUS HRI 420 W	No declarable substances contained
SIRIUS HRI 440 W	In work
SIRIUS HRI 440 W H	In work
SIRIUS HRI 440 W S	In work
SIRIUS HRI 440 W X	No declarable substances contained
SIRIUS HRI 461 W	No declarable substances contained
SIRIUS HRI 461 W S	No declarable substances contained
SIRIUS HRI 470 W S	In work
SIRIUS HRI 470 W RO	In work
SIRIUS HRI 470 W XL	In work
SIRIUS HRI 471 W SN	In work
SIRIUS HRI 550 W	In work

Datablad produktfamilj

Säkerhetsanvisningar

På grund av deras kraftiga ljusstyrka, UV-strålning och höga interna tryck när de används får SIRIUS HRI-lampor endast användas i slutna armaturer som är speciellt konstruerade för detta ändamål. Lämpliga filter måste säkerställa att UV-strålningen reduceras till en acceptabel nivå. Kvicksilver frigges om lampan går sönder. Speciella säkerhetsåtgärder måste vidtas. Ytterligare information finns tillgänglig på begäran eller kan hittas i broschyren som följde med lampan eller i bruksanvisningen.

Applikationsråd

För mer detaljerad applikationsinformation och grafik, vänligen se produktdatablad

Friskrivningsklausul

Kan ändras utan föregående notifiering. Felaktigheter och försummelse undantagna. Se alltid till att använda den senaste utgåvan.