

GFDT400-G1 840-05

GINOLED FLEX Diffuse Top |



Produktegenskaper

- 3 SDCM, CRI80
- Large selection of lighting color temperatures
- 110° viewing angle per module
- Up to 50,000 h lifetime @ tc max

Produktfördelar

- Cut to length each 41.7 mm
- 10x10 mm super slim design, fit for embedded applications
- Diffuse version, top emitting, high light uniformity without spot or dark area
- IP67 protection for truly outdoor application

Användningsområde

- Outdoor and indoor contour lighting
- Skyltar
- Valvbelysning
- Dekorationsbelysning
- Architectural lighting
- Accentbelysning



Produktdatablad

Tekniska data

Elektriska data

Nominell wattstyrka per meter	6,0 W
-------------------------------	-------

Fotometrisk data

Färgtemperatur	4000 K
Färgåtergivningindex Ra	80
Ljuskälla (angiven)	4000 K
SDCM Standardavvikelse färgmatchning	≤3 sdc
Ljusflöde per meter	450 lm
Totalt användbart ljusflöde	2250 lm

Ljustekniska värden

Spridningsvinkel	110 °
Upptid	0,0 s
LED pitch	6.95 mm
Uppvärmningstid (60 %)	0,00 s

LED-modulinformation

Antal LED per minsta enhet	6
Antal LED per meter	144

Mått

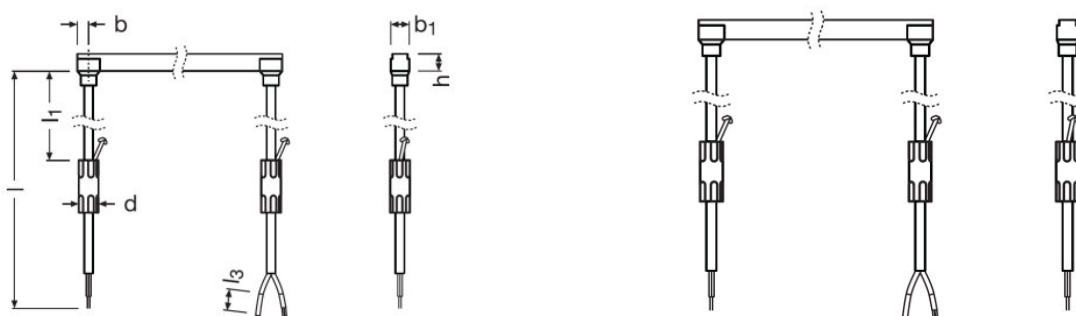

produktvikt	650,00 g
Längd - minsta enheten	41.7 mm
Längd	5000 mm
Bredd	11,0 mm
Höjd	10,5 mm

Produktdatablad

Kabellängd	665,0
------------	-------

Färger & Material

Material i kroppen	Silicone
Material i höljet	Silicone

Temperaturer och driftsförhållanden

Omgivningstemperaturområde	-40...+55 °C
Temperaturbetende enl. IEC 62717	RG0

Livslängder

Antal tändcykler	15000
Beräknad livslängd	50000 h
Ljusnedgångsfaktor	0,70
Nominell livslängd	50000 h

Användningsområden

Lowest bending radius	100 mm
With end piece	Nej
With connection set	Ja
Control interface	-
Detection angle (Light sensor)	-
Detection angle (PIR)	-

Certifikat och Standarder

Skyddstyp	IP67
Energiförbrukning	33 kWh/1000h



Logistikdata

Statistiskt varunummer	85395100000
------------------------	-------------

Environmental information

Information according Art. 33 of EU Regulation (EC) 1907/2006 (REACH)	
Date of Declaration	07-09-2022
Primary Article Identifier	4062172194327
Candidate List Substance 1	No declarable substances contained
Declaration No. in SCIP database	No declarable substances contained

Download

Dokument	
	User instruction GinoLED Diffuse White Flex
	Konformitetsdeklaration GFD SW TW CE 4283939 180823
	Konformitetsdeklaration GINOLED FD TW UK CE 4237513 040221

Ecodesign regulation information:

- This product is considered to be a "containing product" in the sense of Regulations (EU) 2019/2020 and (EU) 2019/2015.
- Tolerances of the reported values, are according to LED Modules Performance standard IEC/EN 62717.
- In general, the replacement of the contained light sources without permanent damage to the product with the use of common available tools is possible in the final application when they can be dismantled from the installation environment and substituted for the necessary number of light sources restoring its full electrical/mechanical/thermal/optical functionality by means of a professional installer. In the contrary, and limited to the LINEARlight Flex Diffuse, LINEARlight Rigid Finesse, GINO LED Flex Diffuse and LUMINENT Milky product families, the contained light source is an integrated part of the containing product and its removal can only be done by causing a permanent damage to the containing product due to its tight mechanical, electrical, optical, thermal interaction and/or environmental protection with or from the containing product. Therefore, a replacement of the light source with the use of common available tools is not justified.
- Dismantling of light sources from containing products at end of life: Containing products with light sources which are scalable in length can be cut to the length of the contained light source and if applicable mechanically detached from protective and/or optical covers. Containing products shall be separated from building material and/or from other additional mounting accessories by means of a professional installer. Separate control gear and light sources must be disposed of at certified disposal companies in accordance with Directive 2012/19/EU (WEEE) in the EU and with Waste Electrical and Electronic Equipment (WEEE) Regulations 2013 in the UK. For this purpose, collection points for recycling centres and take-back systems (CRSO) are available from retailers or private disposal companies, which accept separate control gear and light sources free of charge. In this way, raw materials are conserved and materials are recycled.

Logistiska data

Produktnummer	Produktbeskrivning	Förpackningsenhet (Styck/Enhet)	Dimensioner (längd x bredd x höjd)	Volym	Bruttovikt
4062172194327	GFDT400-G1 840-05	Transportförpackning 3	475 mm x 360 mm x 145 mm	24.80 dm ³	4530.00 g

Produktkoden gäller minsta tillåtna beställningskvantitet. En transportförpackning kan innehålla en eller flera produkter. Vid orderläggning, vänligen ange en eller flera transportförpackningar.

Produktdatablad

Friskrivningsklausul

Subject to change without notice. Errors and omission excepted. Always make sure to use the most recent release.