

DALI SENSOR LS/PD CI G2

DALI SENSOR LS/PD CI G2 | Sensorer



Produktegenskaper

- Light and presence sensor for ceiling integration
- Närvarodetektering via passiv IR-enhet
- Monteringshöjd: 2 ... 5 m
- Funktionsindikator med tvåfärgad lysdiod
- Takinstallation adapter

Produktfördelar

- Flat design, very small structural height
- Simple and fast installation via wire springs
- DALI-2 certified
- DALI Bus powered (No mains connection necessary)
- Multiple sensors connectable to the same DALI line
- Närvarodetektering justerbar mellan 40 ... 90 ° via integrerade luckor
- Integretable in light- and building management systems supporting DALI-2 sensors

Användningsområde

- Lämplig för inomhusapplikationer
- Individuella kontor
- Kontorslandskap
- Klassrum
- Konferensrum
- Korridorer

Produktdatablad

Tekniska data

Elektriska data

Required DALI current (typical)	6 mA
Peak DALI current	16 mA
Maximum start-up time (DALI)	600 ms

Mått

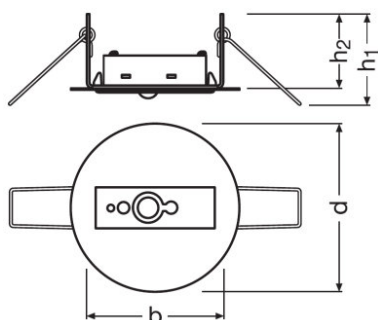

Längd	80,0 mm
Hålavstånd diagonal	73 mm
Höjd	55,0 mm ¹⁾
produktvikt	95,00 g

¹⁾ h1

Temperaturer och driftsförhållanden

Omgivningstemperaturområde	-20...+50 °C
----------------------------	--------------

Användningsområden

Ljusreglerbar	Nej
Dimmer gränssnitt	DALI-2
Maximal installationshöjd	5 m
Detekteringsområde	7 m ²
Detekteringsvinkel	40...90 °
Arbetsområde ljussensor	20...800 lx
Typ av installation	Infällt

Certifikat och Standarder

Skyddstyp	IP20
-----------	------







Logistikdata

Statistiskt varunummer	90318080000
------------------------	-------------

Environmental information

Information according Art. 33 of EU Regulation (EC) 1907/2006 (REACH)	
Date of Declaration	30-06-2023
Primary Article Identifier	4062172072083
Candidate List Substance 1	Lead titanium zirconium oxide
CAS No. of substance 1	12626-81-2
Candidate List Substance 2	Lead
CAS No. of substance 2	7439-92-1
Safe Use Instruction	The identification of the Candidate List substance is sufficient to allow safe use of the article.
Declaration No. in SCIP database	bc731bf9-1aff-4034-a5c1-60231a854935

Download

Dokument	
	User instruction DALI2 SENSOR LSPD CI
	Konformitetsdeklaration DALI G2 Sensor Coupler CE 4202657 03 061020
	CAD-data DALI SENSOR LS PD CI G2 IGS 110820
	CAD-data DALI SENSOR LS PD CI G2 STEP 110820
	CAD-data 2-dim DALI SENSOR LS PD CI G2 2PDF 110820
	CAD-data 3-dim DALI SENSOR LS PD CI G2 CAD3PDF 110820

Logistiska data

Produktnummer	Produktbeskrivning	Förpackningsenhet (Styck/Enhet)	Dimensioner (längd x bredd x höjd)	Volym	Bruttovikt
4062172072083	DALI SENSOR LS/PD CI G2	Transportförpackning 10	217 mm x 217 mm x 180 mm	8.48 dm ³	1229.00 g

Produktkoden gäller minsta tillåtna beställningskvantitet. En transportförpackning kan innehålla en eller flera produkter. Vid orderläggning, vänligen ange en eller flera transportförpackningar.

Produktdatablad

Friskrivningsklausul

Subject to change without notice. Errors and omission excepted. Always make sure to use the most recent release.